

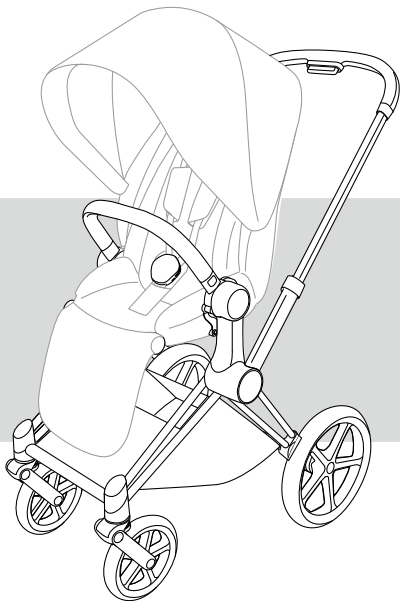

PRIAM

FRAME & SEAT



cybex *Club*

Register here
and unlock
your benefits



EN WARNING
DE WARNUNG
ES ADVERTENCIA
FR AVERTISSEMENT
PT AVISOS
IT WARNING
NL WAARSCHUWING
PL OSTRZEŻENIE
CS UPOZORNĚNÍ
SK UPOZORNENIE
SL OPOZORILO
HR UPOZORENJE
HU FIGYELMEZTETÉS
SE VARNING
NO ADVARSEL
FI VAROITUS
DA ADVARSEL
ET HOIATUS
LV BRĪDINĀJUMS
LT PERSPĖJIMAS
RU ВНИМАНИЕ
UK УВАГА
TR UYARI
EL ΠΡΟΕΙΔΟΠΟΙΗΣΗ
RO AVERTISMENTE
IS VIÐVÖRUN
MT TWISSIJA

AR
FA
YUE 警告
CMN 警告
JA 警告
KO 경고
BG ПРЕДУПРЕЖДЕНИЕ
SR UPOZORENJE
MS AMARAN
HI चेतावनी
TH คำเตือน
SQ PARALAJMËRIM
BS UPOZORENJE
ME UPOZORENJE
MK ПРЕДУПРЕДУВАЊЕ
HY շՊԻՇԱՑՈՒՄ
VI CẢNH BÁO

تحذير
اخطار



EN Tutorial video
DE Videoanleitung
ES Tutorial en vídeo
FR Vidéo de démonstration
PT Video tutorial
IT Video tutorial
NL Instructievideo
PL Film instruktażowy
CS Výchovné video
SK Výchovné video
SL Video z navodili
HR Video s uputama
HU Bemutatóvideó
SE Videosjälvstudiekurs
NO Opplæringsvideo
FI Opetusvideo
DA Vejledende video
ET Õppevideo
LV Ar mācību video
LT Mokomasis vaizdo įrašas
RU Обучающее видео
UK Навчальне відео
TR Öğretici video
EL Εκπαιδευτικό βίντεο
RO Video tutorial
IS Kennslumyndband
MT Tutorial fuq vidjow

AR
FA
YUE 教程視頻
CMN 教程视频
JA チュートリアルビデオ
KO 튜토리얼 동영상
BG Учебно видео
SR Video sa uputstvima
MS Video tutorial
HI ट्यूटोरियल वीडियो
TH วิดีโอแนะนำ
SQ Video udhëzuese
BS Video sa uputstvima
ME Video sa uputstvima
MK Видеоупатство
HY Πλατύνει οδηγίες για την επανάληψη
VI Video hướng dẫn

فيديو تعليمي
ويدئوی آموزشی



EN Maximum weights
DE Maximalgewichte
ES Pesos máximos
FR Poids maximum
PT Pesos máximos
IT Peso massimo
NL Maximumgewicht
PL Dopuszczalna waga
CS Maximální hmotnosti
SK Maximálne hmotnosti
SL Največje teže
HR Maksimalne težine
HU Maximális súlyok
SE Max.vikter
NO Maksimumsvektor
FI Enimmäispainot
DA Maksimumvægt
ET Maksimaalne kaal
LV Maksimālais svars
LT Didžiausi svoriai
RU Максимальная масса
UK Максимальна вага

TR Maksimum ağırlıklar
EL Μέγιστο βάρος
RO Greutăți maxime
IS Hámarksþyngd
MT Piżijiet massimi
AR الأوزان القصوى
FA حداکثر وزن
YUE 最大重量
CMN 最大重量
JA 最大重量
KO 최대 하중
BG Максимални тегла
SR Maksimalne težine
MS Berat maksimum
HI अधिकतम वजन
TH น้ำหนักสูงสุด
SQ Peshat maksimale
BS Maksimalne težine
ME Maksimalne težine
MK Максимални тежини
HY Առավելագույն քաշեր
VI Các mức cân nặng tối đa

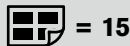

EN Product registration
DE Produktregistrierung
ES Registro del producto
FR Enregistrement du produit
PT Registo do produto
IT Registrazione del prodotto
NL Productregistratie
PL Rejestracja produktu
CS Registrace výrobku
SK Registrácia výrobku
SL Registracija izdelka
HR Registracija proizvoda
HU Termékregisztráció
SE Produktregistrering
NO Produktregistrering
FI Tuotteen rekisteröinti
DA Produktregistrering
ET Toote registreerimine
LV Produkta reģistrācija
LT Gaminio registracija
RU Регистрация продукта
UK Реєстрація продукту

TR Ürün kaydı
EL Καταχώριση προϊόντος
RO Înregistrarea produsului
IS Skráning tækis
MT Reġistrazzjoni tal-prodott
AR تسجيل المنتج
FA ثبت محصول
YUE 產品註冊
CMN 产品注册
JA 製品の登録
KO 제품 등록
BG Регистрация на продукта
SR Registracija proizvoda
MS Pendaftaran produk
HI उत्पाद पंजीकरण
TH การลงทะเบียนผลิตภัณฑ์
SQ Regjistrimi i produktit
BS Registracija proizvoda
ME Registracija proizvoda
MK Регистрација на производ
HY Արձանագրություն
VI Đăng ký sản phẩm



= 16

EN	Set up	TR	Kurulum
DE	Aufbau	EL	Στήσιμο
ES	Instalación	RO	Setare
FR	Montage	IS	Uppsetning
PT	Preparação	MT	Konfigurazzjoni
IT	Configurazione	AR	
NL	Opbouw	FA	تنصيب برپا کردن
PL	Montaż	YUE	設置
CS	Nastavení	CMN	设置
SK	Nastavenie	JA	セットアップ
SL	Nastavitev	KO	설정
HR	Postavljanje	BG	Настройка
HU	Felszerelés	SR	Postavljanje
SE	Inställning	MS	Persediaan
NO	Oppsett	HI	सेट अप
FI	Asennus	TH	การติดตั้ง
DA	Opsætning	SQ	Konfigurimi
ET	Seadistamine	BS	Postavljanje
LV	Uzstādīšana	ME	Postavljanje
LT	Nuostatos	MK	Поставување
RU	Установка	HY	Շարժափոխում
UK	Встановлення	VI	Cài đặt



= 32

EN	Brake	TR	Fren
DE	Bremse	EL	Φρένα
ES	Freno	RO	Frână
FR	Frein	IS	Bremsa
PT	Bloqueio	MT	Brejik
IT	Freno	AR	المكابح
NL	Rem	FA	ترمز
PL	Hamulec	YUE	剎車
CS	Brzda	CMN	剎車
SK	Brzda	JA	ブレーキ
SL	Zavora	KO	브레이크
HR	Kočnica	BG	Спирачка
HU	Fék	SR	Kočnica
SE	Broms	MS	Brek
NO	Brems	HI	ब्रेक
FI	Jarru	TH	เบรค
DA	Bremse	SQ	Frenat
ET	Pidur	BS	Kočnica
LV	Bremze	ME	Kočnica
LT	Stabdys	MK	Сопирачка
RU	Тормоза	HY	Արգելակ
UK	Гальма	VI	Phanh thắng



 = 33

EN	Folding	TR	Katlama
DE	Faltung	EL	Αναδίπλωση
ES	Plegado	RO	Pliere
FR	Pliant	IS	Brjóta saman
PT	Fecho	MT	Tiwi
IT	Ripiegamento	AR	
NL	Vouwen	FA	
PL	Składanie	YUE	折疊
CS	Skládání	CMN	折疊
SK	Zloženie	JA	折りたたみ
SL	Zlaganje	KO	접기
HR	Preklapanje	BG	Сгъване
HU	Összecsukás	SR	Preklapanje
SE	Ihopfällning	MS	Lipat
NO	Sammenlegging	HI	फोल्डिंग
FI	Kokoon taittaminen	TH	การพับ
DA	Sammenklapning	SQ	Palosja
ET	Kokkuvoltimine	BS	Preklapanje
LV	Salocīšana	ME	Preklapanje
LT	Lankstymas	MK	Склопување
RU	Складывание	HY	Ծախելը
UK	Складання	VI	Gập lại

قابلية للطي
تا کردن



 = 35

EN	Harness	TR	Emniyet kemeri
DE	Gurtsystem	EL	Συγκράτηση
ES	Arnés	RO	Centură
FR	Harnais	IS	Beisli
PT	Arnês	MT	Ċinga tas-sigurtà
IT	Imbracatura	AR	طقم الشد
NL	Harnas	FA	سیدستم مهار
PL	Szelki	YUE	安全帶
CS	Popruh	CMN	安全帶
SK	Popruh	JA	安全ベルト
SL	Varnostni pas	KO	하네스
HR	Sustav vezivanja	BG	Сбруя
HU	Biztonsági öv	SR	Sistem vezivanja
SE	Sele	MS	Abah-abah
NO	Beltesystem	HI	कबच
FI	Vyöjärjestelmä	TH	ระบบสายรัด
DA	Selesystem	SQ	Pajimet
ET	Turvarihmad	BS	Sistem vezivanja
LV	Drošības josta	ME	Sistem vezivanja
LT	Diržai	MK	Сигурносен каиш
RU	Ремни безопасности	HY	Ամրագրուի
UK	Ремінь	VI	Dây an toàn



 = 38

EN Two wheel mode	TR İki tekerlekli mod
DE Zweirad-Modus	EL Λειτουργία δύο τροχών
ES Modo de dos ruedas	RO Mod cu două roți
FR Mode deux roues	IS Stilling fyrir tvö hjól
PT Modo de duas rodas	MT Modalità b'żewġ roti
IT Modalità a due ruote	AR وضع العجلتين
NL Tweewiel-modus	FA حالت دوچرخ
PL Typ dwukołowy	YUE 兩輪模式
CS Režim dvou kol	CMN 两轮模式
SK Dvojkoľosový režim	JA 2輪モード
SL Dvokolesni način	KO 두 휠 모드
HR Režim rada s dva kotača	BG Режим с две колела
HU Kétkerek mód	SR Režim rada na dva točka
SE Tvåhjulsläge	MS Mod dua roda
NO Tohjulmodus	HI दो पहिया मोड
FI Kaksipyöräinen tila	TH โหมดสองล้อ
DA Tohjultilstand	SQ Modaliteti me dy rrota
ET Kahe ratta režiim	BS Režim rada na dva točka
LV Divu ritenū režīms	ME Režim rada na dva točka
LT Dviejų ratų režimas	MK Режим за две тркала
RU Двухколесный режим	HY Երկախիկի ռեժիմ
UK Двоколісний режим	VI Chế độ hai bánh xe



 = 40

EN Bumper bar	TR Tampon çubuğu
DE Schutzbügel	EL Μπάρα διάταξης προστασίας
ES Barra de seguridad	RO Bară de protecție
FR Barre de protection	IS Þverbiti
PT Barra de segurança	MT Strixxa tal-bumper
IT Barra paraurti	AR عارضة ممتص الصدمات
NL Veiligheidsbeugel	FA میله ضربهگیر
PL Pałak zabezpieczający	YUE 保險杠
CS Dětské madlo	CMN 保險杠
SK Dětská rúčka	JA バンパーバー
SL Varnostni lok	KO 범퍼 바
HR Štitnik	BG Броня
HU Karfa	SR Štitnik
SE Stötfångare	MS Bar bumper
NO Fender	HI बम्पर बार
FI Suojakaari	TH แล่กันชน
DA Sikkerhedsbøjle	SQ Shufra e parakolpiti
ET Turvakaar	BS Štitnik
LV Aizsargloks	ME Štitnik
LT Amortizatoriaus strypas	MK Одбојник
RU Поручень	HY Թափարգել
UK Обмежувальний поручень	VI Thanh chống va đập



= 40

EN Seat direction	TR Koltuk yönü
DE Sitzrichtung	EL Κατεύθυνση καθίσματος
ES Dirección de la silla	RO Direcție scaun
FR Sens du siège	IS Sætisstefna
PT Orientação do assento	MT Direzzjoni tas-sit
IT Direzione di seduta	AR اتجاه المقعد
NL Zitrichting	FA جهت صندلی
PL Kierunek siedzenia	YUE 座椅方向
CS Směr sedadla	CMN 座椅方向
SK Smer sedadla	JA シートの方向
SL Smer sedeža	KO 좌석 방향
HR Smjer sjedala	BG Посока на седалката
HU Ülészirány	SR Smer sedišta
SE Sitsriktning	MS Arah kerusi
NO Seteretning	HI सीट दिशा
FI Istumasuunta	TH ทิศทางที่นั่ง
DA Sæderetning	SQ Drejtimi i ndenjësës
ET Istme suund	BS Smjer sjedišta
LV Sēdekļa virziens	ME Smjer sjedišta
LT Kėdutės kryptis	MK Правец на седиште
RU Направление сиденья	HY Ստղամտքի ուղղություն
UK Напрямок сидіння	VI Hướng ghế ngồi



= 41

EN Backrest	TR Arkalık
DE Rückenlehne	EL Πλάτη
ES Respaldo	RO Spătar
FR Dossier	IS Bak
PT Encosto de costas	MT Serh id-dahar
IT Schienale	AR مسند الظهر
NL Rugleuning	FA پشتی
PL Oparcie	YUE 靠背
CS Opěradlo	CMN 靠背
SK Operadlo	JA 背もたれ
SL Naslonjalo	KO 등받이
HR Naslon	BG Облегалка
HU Háttámla	SR Naslon
SE Ryggstöd	MS Penyangar belakang
NO Rygglene	HI बैकरेस्ट
FI Selkänöja	TH พนักพิง
DA Ryglæn	SQ Mbështetësja e shpinës
ET Seljatugi	BS Naslon
LV Atzveltne	ME Naslon
LT Nugaros atlošas	MK Наслон за грб
RU Спинка	HY Թիկնակ
UK Спинка	VI Phấn tựa lưng



= 41

EN	Legrest	TR	Bacak desteği
DE	Beinstütze	EL	Στήριγμα ποδιών
ES	Reposapiés	RO	Suport picior
FR	Repose-pieds	IS	Fótahvíla
PT	Apoio de pernas	MT	Serħ is-saqajn
IT	Poggiagambe	AR	ميمندد الساق
NL	Beensteun	FA	جاپایی
PL	Podnózek	YUE	腿托
CS	Opěrka nohou	CMN	腿托
SK	Opierka nôh	JA	足のせ
SL	Naslon za noge	KO	다리받이
HR	Naslon za noge	BG	Подложка за крака
HU	Lábtartó	SR	Naslon za noge
SE	Benstöd	MS	Tempat letak kaki
NO	Benstøtte	HI	लेगरेस्ट
FI	Jalkatuki	TH	ที่วางขา
DA	Benstøtte	SQ	Mbështetësja e këmbëve
ET	Jalatugi	BS	Naslon za noge
LV	Kāju balsts	ME	Naslon za noge
LT	Kojų atrama	MK	Наслон за нозе
RU	Подставка для ног	HY	Ուղեքրի հեղման կտտ
UK	Опора для ніг	VI	Phàn tựa chân



= 42

EN	Sun canopy	TR	Güneş başlığı
DE	Sonnenverdeck	EL	Κουκούλα για τον ήλιο
ES	Capota para el sol	RO	Copertină
FR	Pare-soleil	IS	Sólartjald
PT	Capota solar	MT	Kopertura mix-xemx
IT	Parasole	AR	مظلة الشمس
NL	Zonnekap	FA	سایبان
PL	Oślona przeciwsłoneczna	YUE	遮陽蓬
CS	Stříška proti slunci	CMN	遮阳蓬
SK	Strieška proti slnku	JA	日よけ力バー
SL	Senčnik za zaščito pred soncem	KO	선 캐노피
HR	Tenda za sunce	BG	Тента
HU	Kupola	SR	Tenda za sunce
SE	Solsufflett	MS	Kanopi matahari
NO	Solskjerm	HI	शुप छतरी
FI	Aurinkokatos	TH	หลังค้ำบังแดด
DA	Solkaleche	SQ	Strea për diellin
ET	Päikesevari	BS	Tenda za sunce
LV	Saules aizsegs	ME	Tenda za sunce
LT	Stogelis nuo saulės	MK	Стреа за сонце
RU	Солнцезащитный козырек	HY	Արևապաշտպան ծածկ
UK	Тент від сонця	VI	Mái che nắng

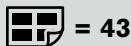

EN	Handle bar
DE	Schiebegriff
ES	Manillar
FR	Poignée de poussée
PT	Guiador
IT	Manubrio
NL	Duwstang
PL	Uchwyt
CS	Madlo
SK	Rukoväť
SL	Ročaj
HR	Ručice
HU	Tolókar
SE	Handtag
NO	Håndtak
FI	Työntökahva
DA	Styr
ET	Sang
LV	Rokturis
LT	Rankena
RU	Рукоятка
UK	Рукоятка

TR	Tutma sapı
EL	Ράβρος λαβής
RO	Mâner
IS	Handfang
MT	Handle bar
AR	عارضة المقبض
FA	میله دسته
YUE	把手
CMN	把手
JA	ハンドルパー
KO	핸들 바
BG	Кормило
SR	Ručke
MS	Bar pemegang
HI	हैंडल बार
TH	ด้ามจับ
SQ	Shufra e dorezës
BS	Ručice
ME	Ručke
MK	Рачка
HY	Վարձափարձան բռնակ
VI	Tay cầm

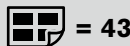

EN	Swivel locks	TR	Tekerlek kilidi
DE	Schwenkradsperre	EL	Περιστροφόμενες κλειδαριές
ES	Bloqueos de dirección	RO	Încuietori pivotante
FR	Verrous pivotants	IS	Snúningslásar
PT	Bloqueios de rotação	MT	Lokks li jduru
IT	Blocchi girevoli	AR	أقفال دوران العجلات
NL	Zwenkvergrendeling	FA	قفل های نوسان
PL	Blokada obrotu	YUE	旋轉鎖
CS	Aretační zámky	CMN	旋轉鎖
SK	Aretačné zámky	JA	回転ロック
SL	Blokada vrtenja	KO	회전 잠금장치
HR	Zaključavanje okretanja	BG	Завъртащи се ключалки
HU	Beállás-zár	SR	Zakretni mehanizmi
SE	Vridlås	MS	Kunci ayun
NO	Svingelåser	HI	कुंडा ताले
FI	Kääntölukko	TH	ตัวล็อกแบบหมุน
DA	Drejelås	SQ	Kuçja e rrotave
ET	Pöördlukustus	BS	Zakretni mehanizmi
LV	Rotācijas bloķētāji	ME	Zakretni mehanizmi
LT	Šarnyriniai fiksatoriai	MK	Заклучување на тркалата
RU	Блокировки вращения	HY	Պտտվողի կողպիչներ
UK	Замок шарніра	VI	Khóa xoay

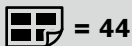

= 44

EN	Removing the wheels	TR	Tekerlekleri çıkarma
DE	Entfernen der Räder	EL	Αφαίρεση των τροχών
ES	Quitar las ruedas	RO	Îndepărtarea roților
FR	Retrait des roues	IS	Fjarlægja hjól
PT	Remover as rodas	MT	Tneħħija tar-roti
IT	Rimozione delle ruote	AR	فك العجلات
NL	De wielen verwijderen	FA	باز کردن چرخ‌ها
PL	Zdejmowanie kółek	YUE	拆卸車輪
CS	Odstranění koleček	CMN	拆卸车轮
SK	Odstránenie koliesok	JA	車輪の取り外し
SL	Odstranjevanje koles	KO	휠 제거
HR	Uklanjanje kotača	BG	Демонтиране на колелата
HU	Kerekek eltávolítása	SR	Uklanjanje točkova
SE	Ta bort hjulen	MS	Menanggalkan roda
NO	Fjerne hjulene	HI	फहियों को हटाना
FI	Pyörien poisto	TH	การถอดล้อ
DA	Fjernelse af hjulene	SQ	Heqja e rrotave
ET	Rataste eemaldamine	BS	Uklanjanje točkova
LV	Riteņu atvienošana	ME	Uklanjanje točkova
LT	Ratų nuėmimas	MK	Отстранување на тркалата
RU	Снятие колес	HY	Անհիվանելը հասելը
UK	Зняття коліс	VI	Tháo bánh xe

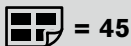

= 45

EN	Removing the fabric	TR	Kılıfı çıkarma
DE	Entfernen des Bezuges	EL	Αφαίρεση του υφάσματος
ES	Quitar la tela	RO	Îndepărtarea țesăturii
FR	Retrait du tissu	IS	Fjarlægja efni
PT	Remover o tecido	MT	Tneħħija tad-drapp
IT	Rimozione del tessuto	AR	فك القماش
NL	De stof verwijderen	FA	برداشتن پارچه
PL	Zdejmowanie pokrycia	YUE	拆除罩布
CS	Odstranění látky	CMN	拆除罩布
SK	Odstránenie látky	JA	カバーの取り外し
SL	Odstranjevanje blaga	KO	페브릭 제거
HR	Uklanjanje tkanine	BG	Демонтиране на плата
HU	Huzat eltávolítása	SR	Uklanjanje tkanine
SE	Ta bort tyget	MS	Menanggalkan fabrik
NO	Fjerne stoffet	HI	कपड़ा हटाना
FI	Kankaan poisto	TH	การถอดผ้า
DA	Fjernelse af stoffet	SQ	Heqja e copës
ET	Kanga eemaldamine	BS	Uklanjanje tkanine
LV	Pārklājuma atvienošana	ME	Uklanjanje tkanine
LT	Audinio nuėmimas	MK	Отстранување на навлаката
RU	Снятие ткани	HY	Գործվածքը հանելը
UK	Зняття матерії	VI	Tháo phần vải bọc



= 46

EN	Carry Cot	TR	Portbebe
DE	Kinderwagenaufsatz	EL	Πορτ-μπεμπέ
ES	Capazo	RO	Landou portabil
FR	Navelle bébé	IS	Burðarrúm
PT	Alcofa	MT	Carry Cot
IT	Culla portatile	AR	سرير محمول
NL	Zitbak	FA	ساک حمل نوزاد
PL	Gondola wózka dziecięcego	YUE	便攜嬰兒床
CS	Hluboká korba	CMN	便携嬰兒床
SK	Korba na prenášanie	JA	持ち運びベッド
SL	Nosilna košara	KO	캐리콧
HR	Ležaljka za prenošenje	BG	Легло за носене
HU	Mózeskosár	SR	Dodatak za kolica
SE	Barnvagnslift	MS	Katil Bayi Bimbit
NO	Babybag	HI	कैरी कॉट
FI	Kantolaukku	TH	ตะกร้าที่นอนเด็ก
DA	Babylift	SQ	Djep
ET	Vankrikorv	BS	Dodatak za kolica
LV	Bērnu gultīņa	ME	Dodatak za kolica
LT	Nešiojamasis lopšys	MK	Кошница за носење
RU	Переносная люлька	HY	Սանկալակն շարժական
UK	Переносне дитяче ліжечко	VI	Nôi xách tay

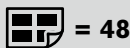

= 48

EN	Infant Car Seat	TR	Bebek Araba Koltuğu
DE	Babyschale	EL	Παιδικό κάθισμα αυτοκινήτου
ES	Silla infantil para coche	RO	Scaunul auto pentru infant
FR	Siège auto pour enfant	IS	Smábarnabílstóll
PT	Cadeira auto infantil	MT	Sit tal-Karozza tat-Tfal
IT	Seggiolino per auto	AR	مقعد سيارة للرضع
NL	Autostoeltje	FA	صندلی خودرو برای نوزاد
PL	Fotelik dla niemowlaka	YUE	嬰兒汽車座椅
CS	Vajíčko	CMN	婴儿汽车座椅
SK	Autosedáčka pre dojčatá	JA	幼児用カーシート
SL	Avtosedež za dojenčke	KO	유아용 카시트
HR	Autosjedalica za bebe	BG	Бебешка седалка за автомобил
HU	Gyermek autósülés	SR	Auto sedište za bebe
SE	Bilbarnstol	MS	Kerusi Keselamatan Bayi
NO	Barnebilsete	HI	शिशु कार सीट
FI	Lasten istuin	TH	คาร์ซีทสำหรับเด็กทารก
DA	Autostol	SQ	Sexholino
ET	Imiku turvatool	BS	Auto sjedište za bebe
LV	Zīdaiņu sēdekļis	ME	Auto sjedište za bebe
LT	Automobilinė naujagimio kėdutė	MK	Детско седиште за автомобил
RU	Детское автокресло	HY	Սկսնաբեթակայի սանկալակն օտոմոբիլի
UK	Автокрісло для немовлят	VI	Ghế xe dành cho trẻ sơ sinh

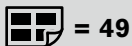

EN	Rain cover	TR	Yağmurluk
DE	Regenverdeck	EL	Καλύπτρα βροχής
ES	Funda para la lluvia	RO	Prelată de ploaie
FR	Housse de pluie	IS	Regn yfirbreiðsla
PT	Capa de chuva	MT	Għata mix-xita
IT	Parapioggia	AR	غطاء المطر
NL	Regenhoes	FA	روکش باران
PL	Oslona od deszczu	YUE	防雨罩
CS	Pláštěnka	CMN	防雨罩
SK	Kryt proti dažďu	JA	雨よけ
SL	Dežna prevleka	KO	레인커버
HR	Pokrivač za kišu	BG	Дъждобран
HU	Esővédő	SR	Pokrivač za kišu
SE	Regnskydd	MS	Pelindung hujan
NO	Kalesje	HI	रेन कवर
FI	Sadesuoja	TH	ผ้าคลุมกันฝน
DA	Regnslag	SQ	Mbulesë për shiun
ET	Vihmakate	BS	Pokrivač za kišu
LV	Pretlietus pārvalks	ME	Pokrivač za kišu
LT	Uždangalas nuo lietaus	MK	Прекривка за дожд
RU	Дождевик	HY	Անձրևապաշտպան ծածկ
UK	Дощовик	VI	Tấm che mưa

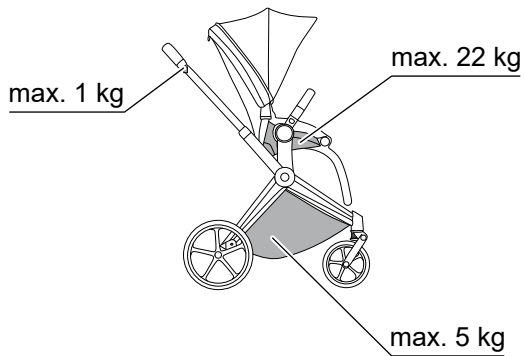

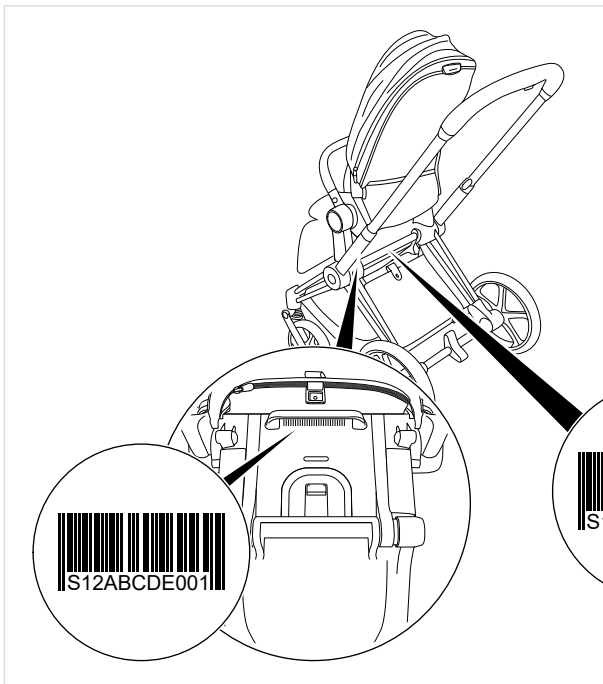

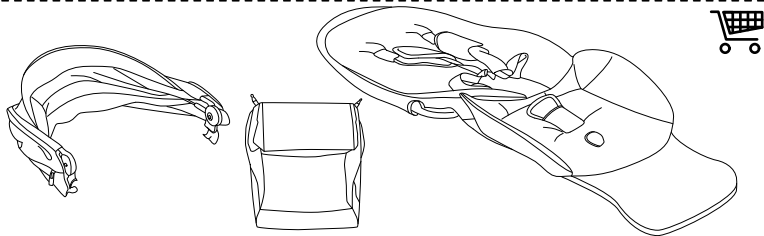
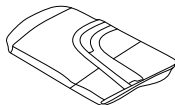
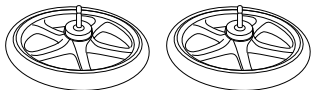
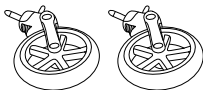
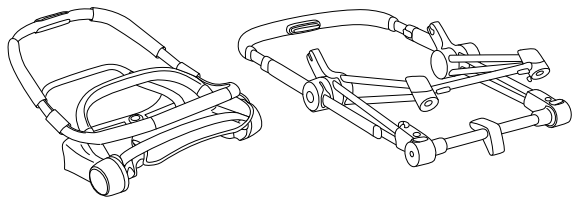

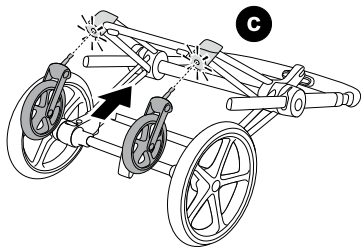
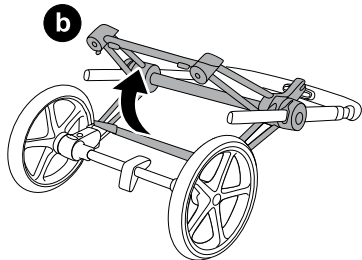
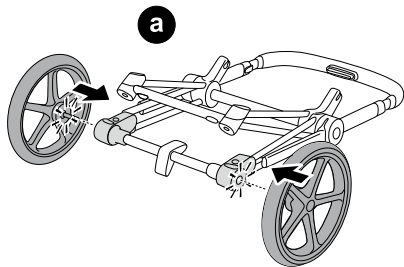

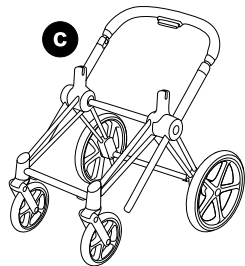
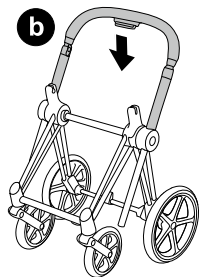
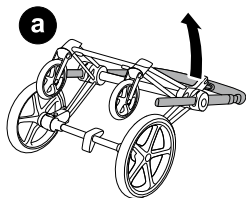

3

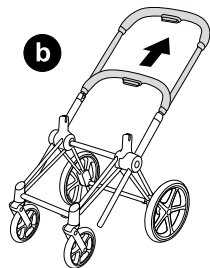
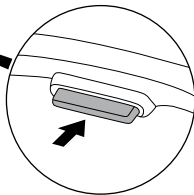
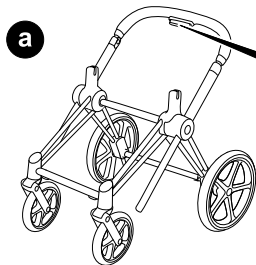

4

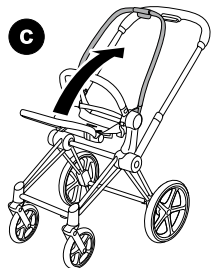
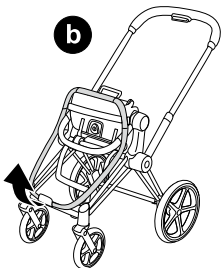
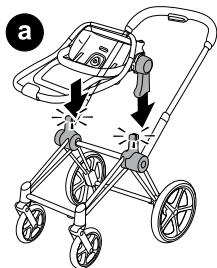

5

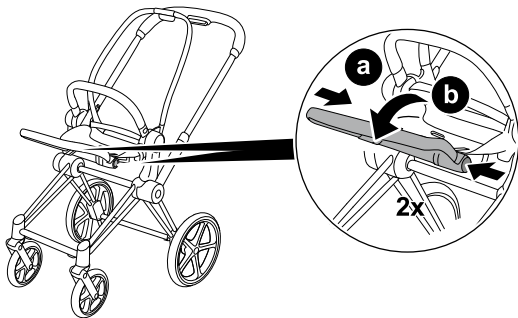

6

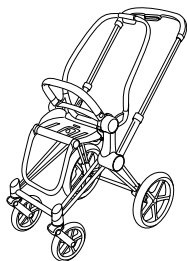

7

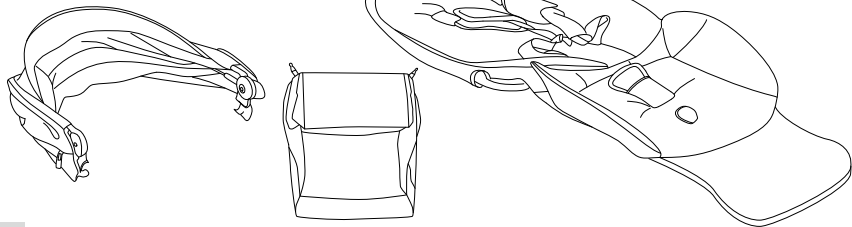

1

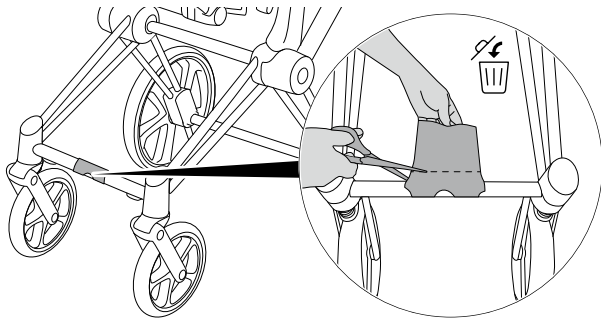

2

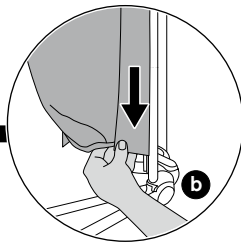
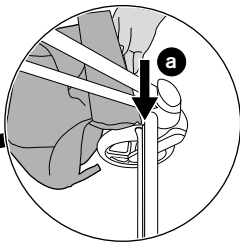
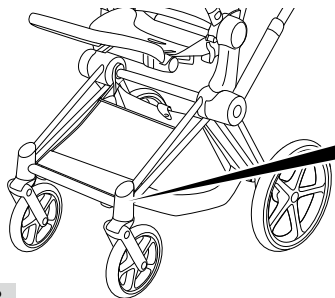

3

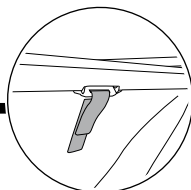
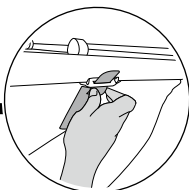
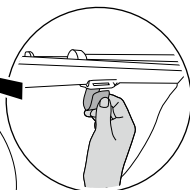
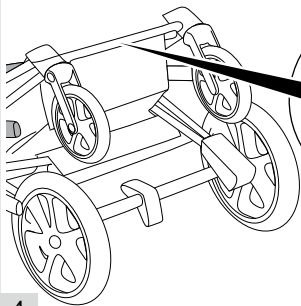

4

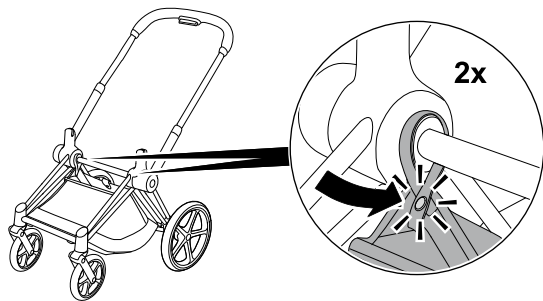

5

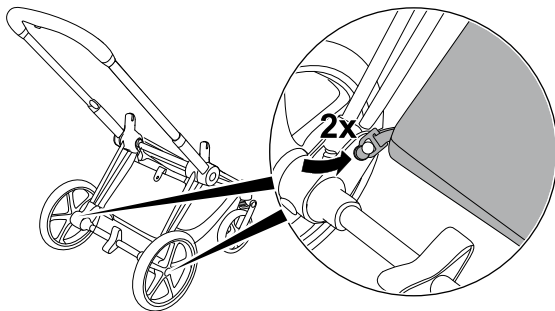

6

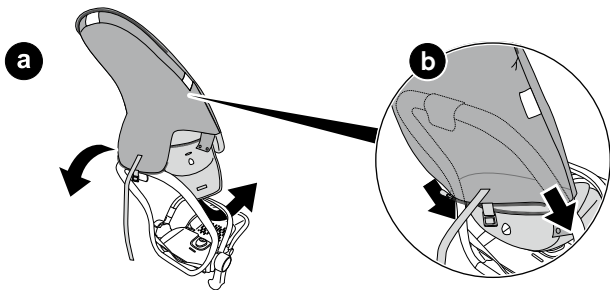

7

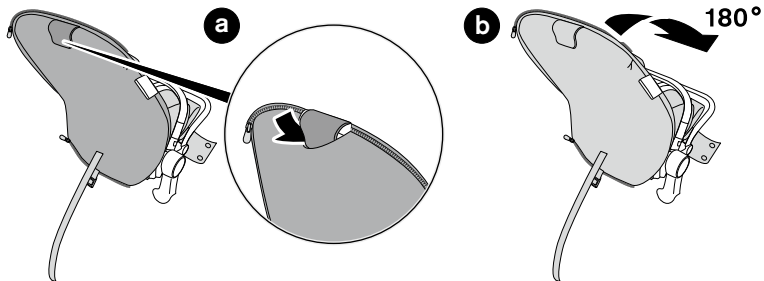

8

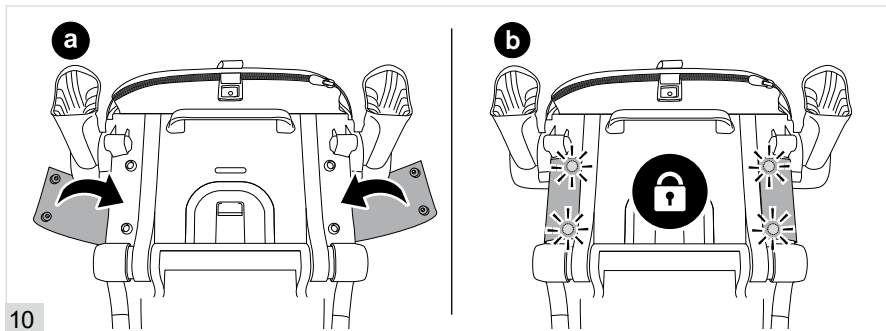
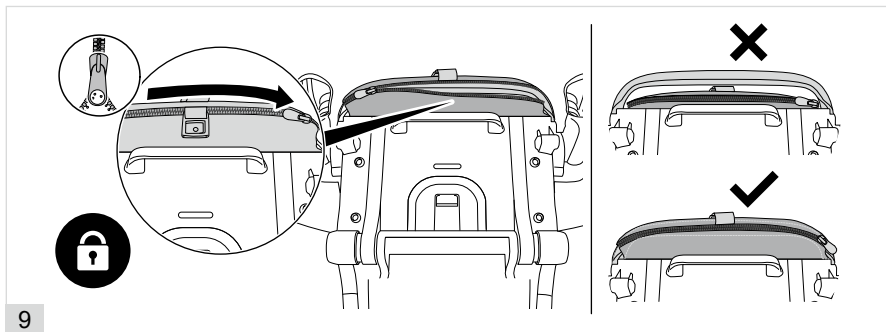

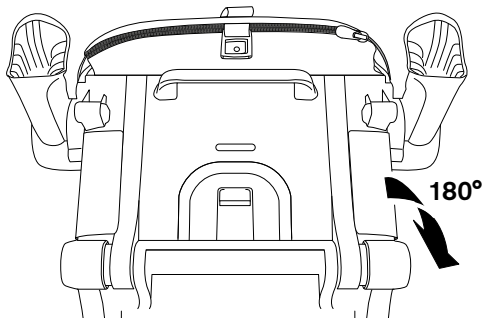

11

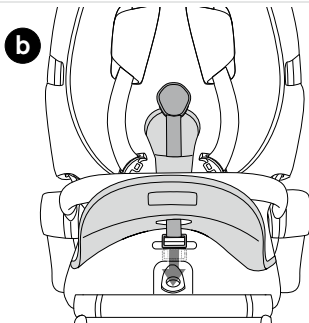
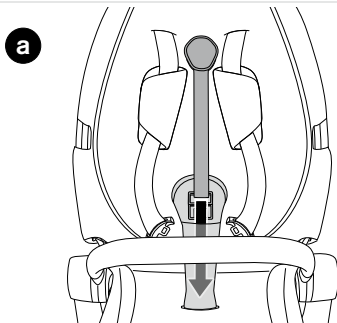

26

12

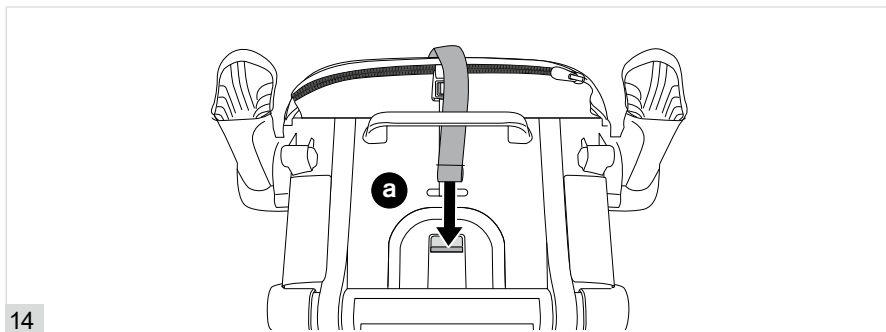
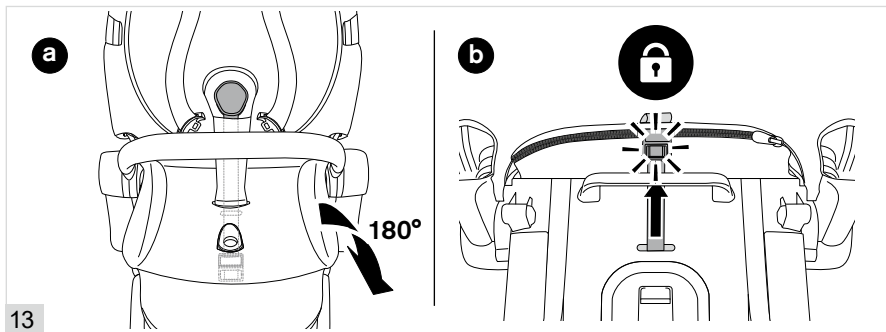

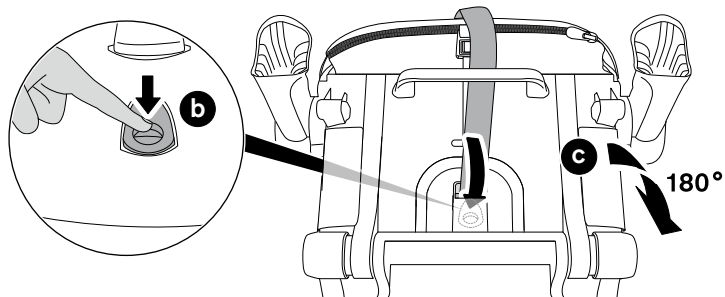

15

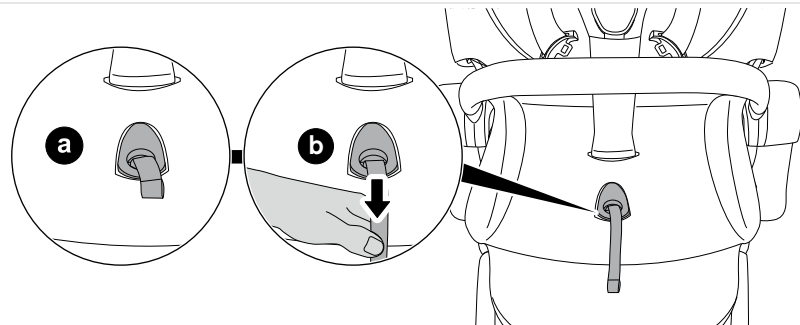

16

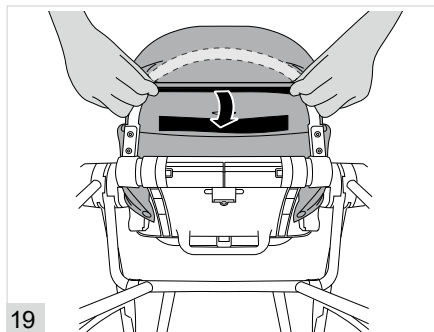
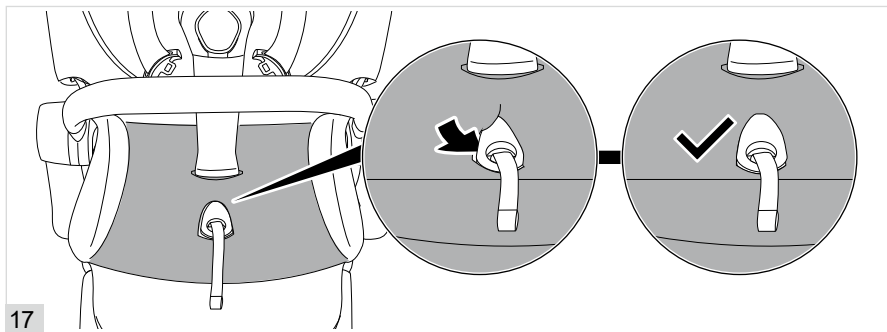

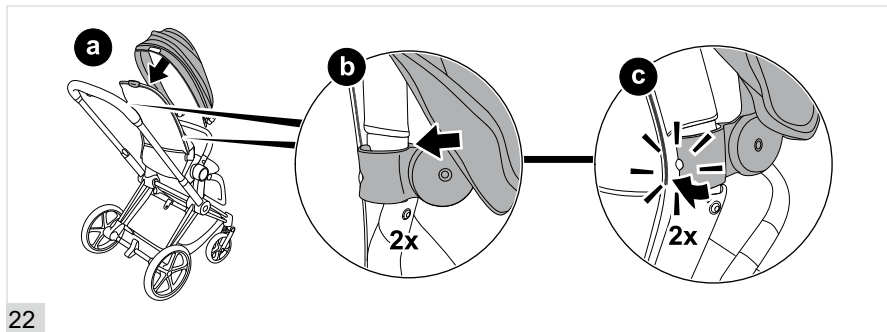
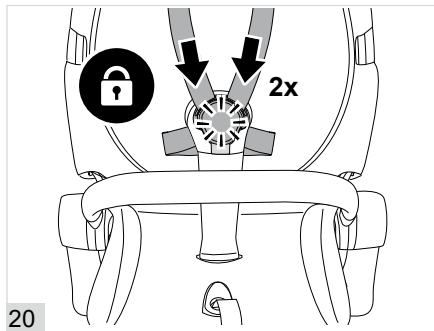

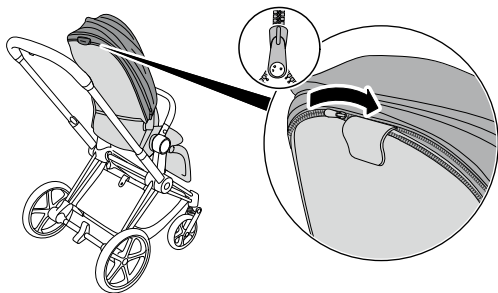

23

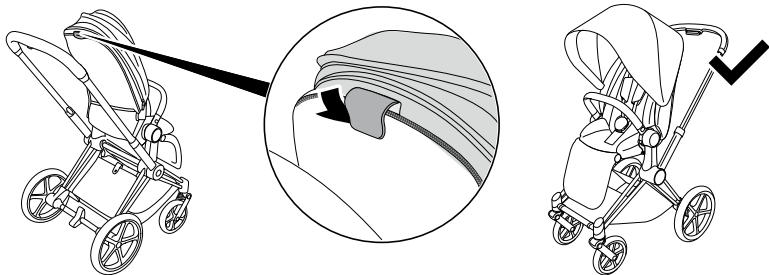

24

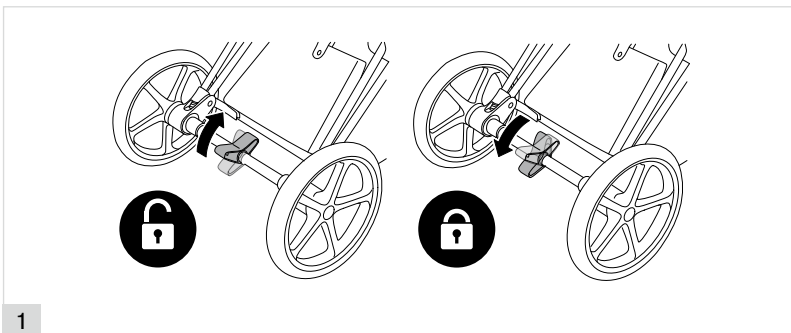

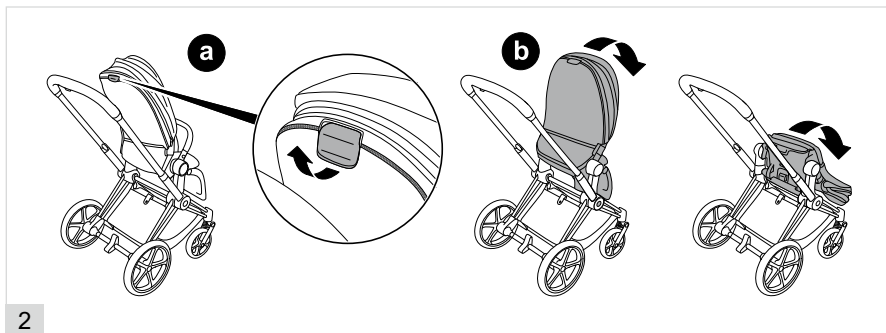
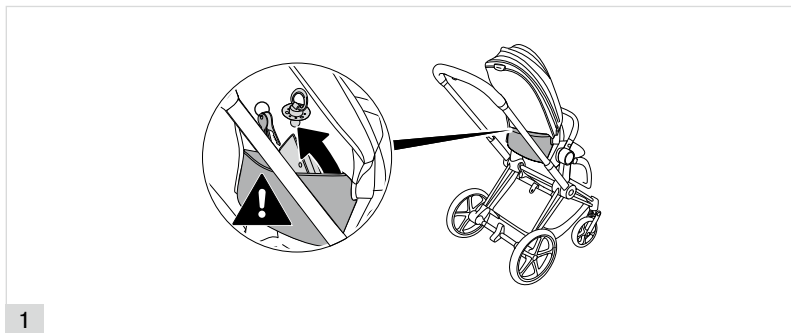

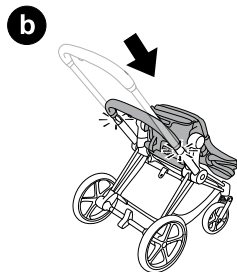
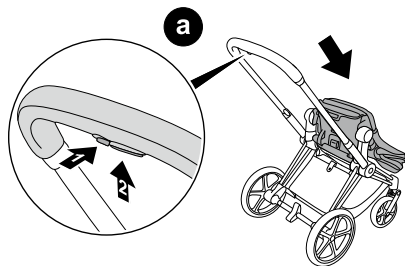

3

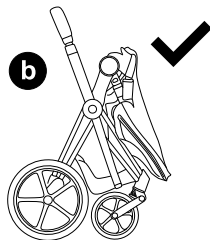
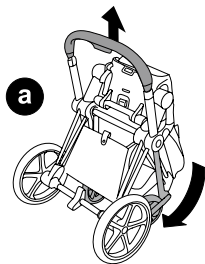

34

4

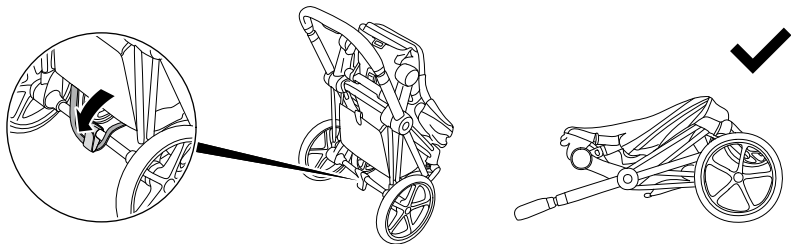

5

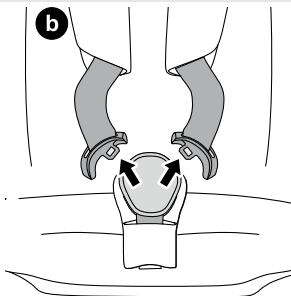
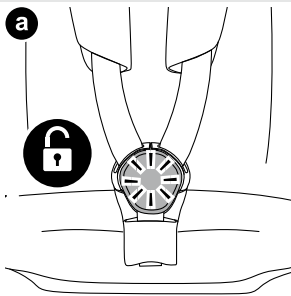

1



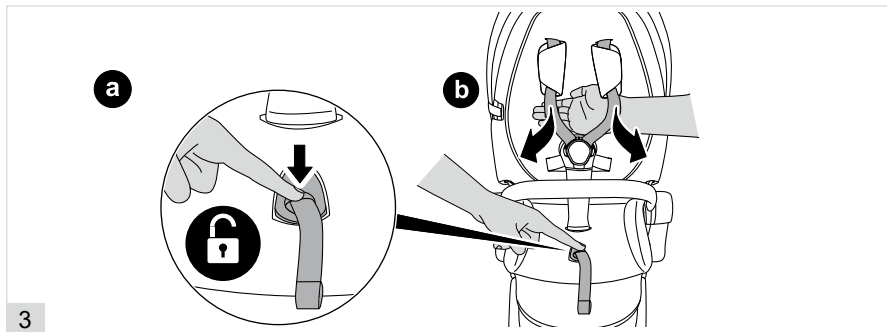
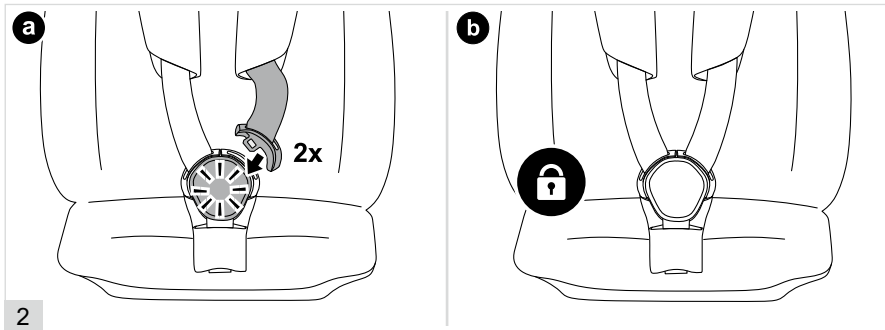

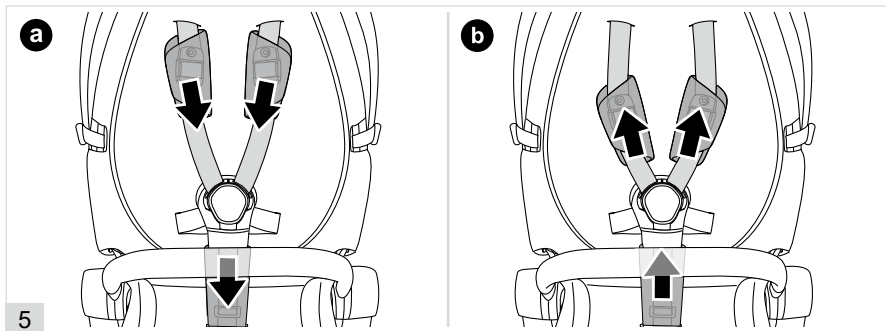
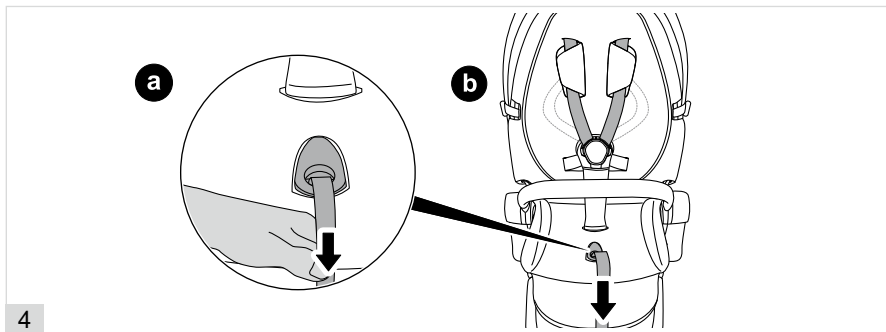

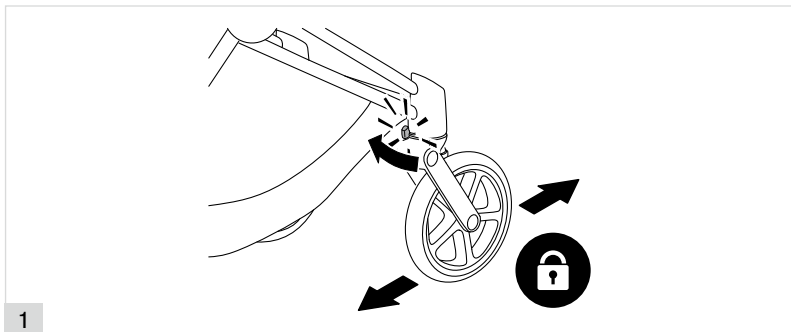
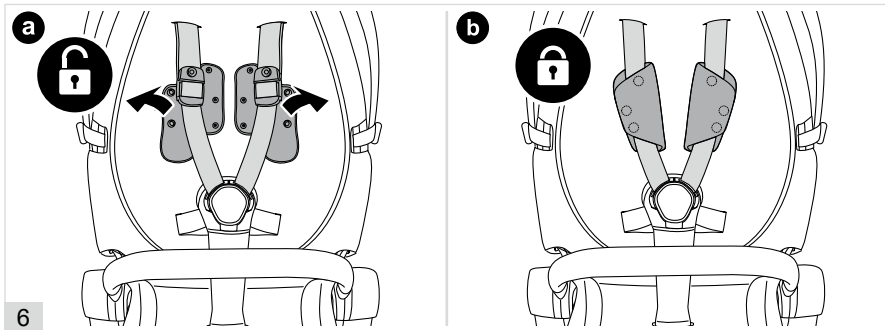

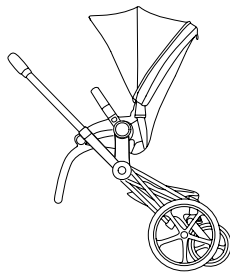
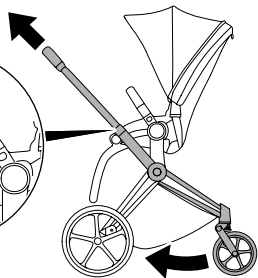
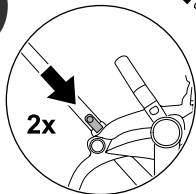

2

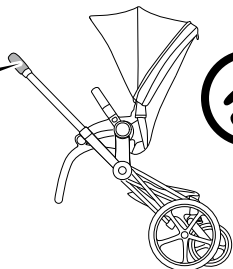
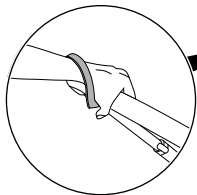

3

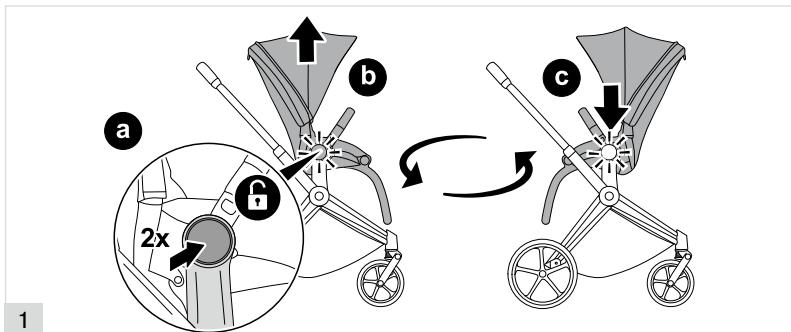
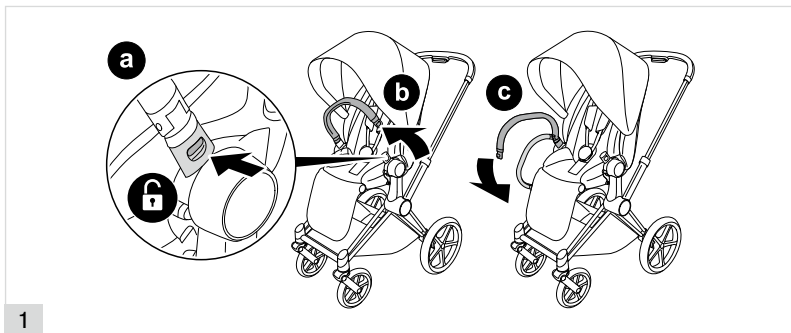

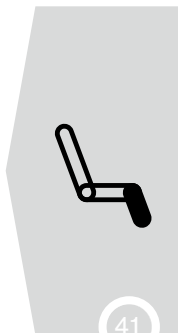
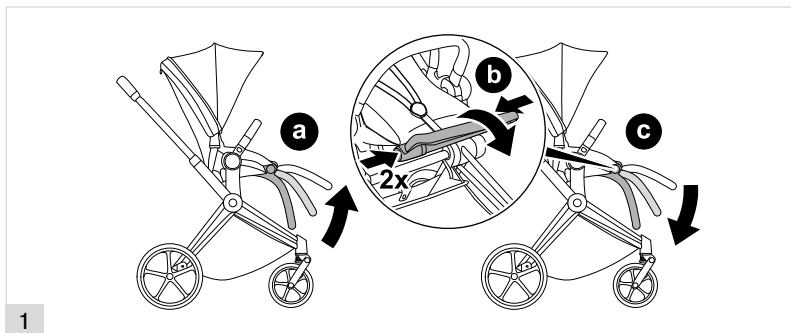
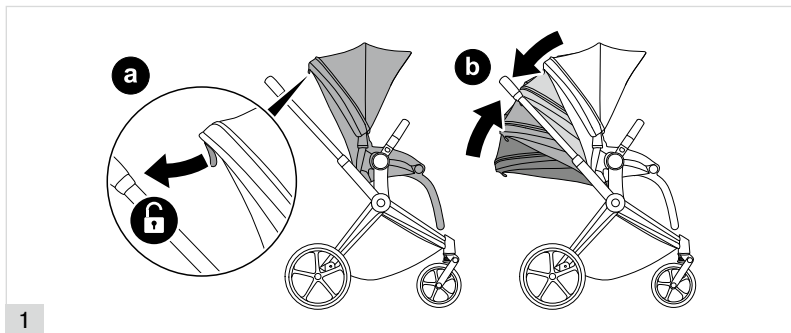

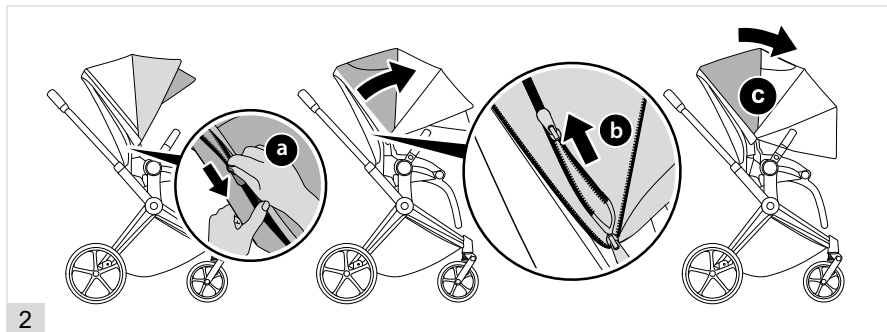
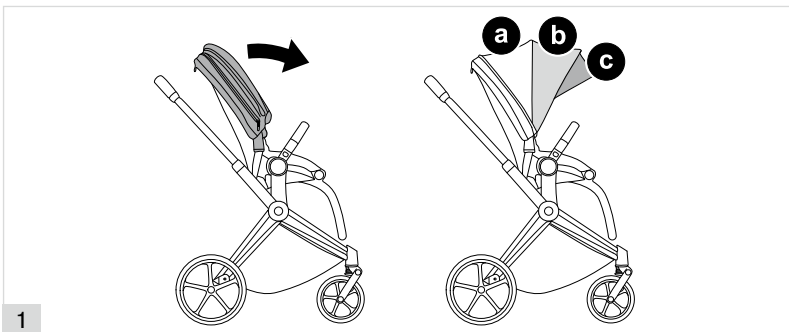

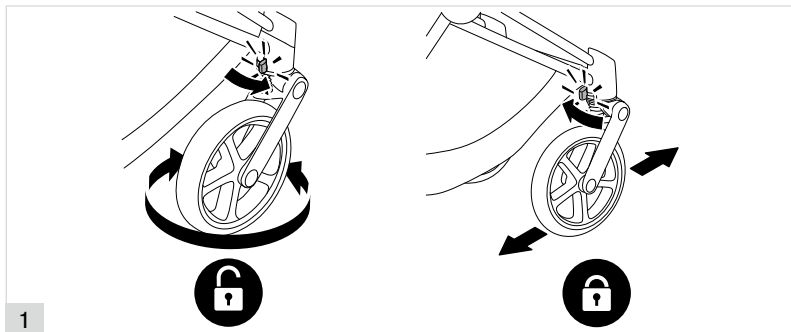
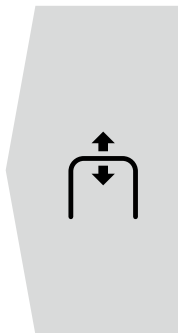
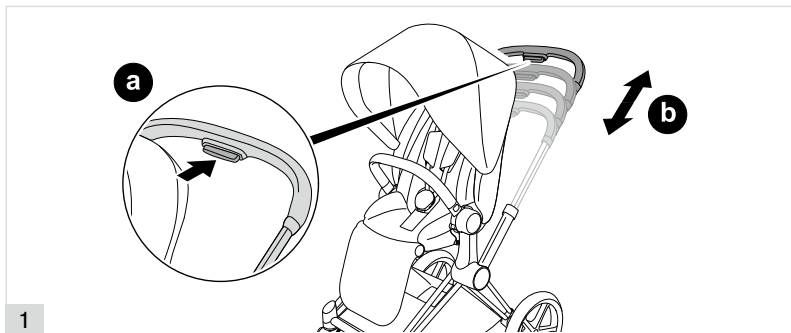

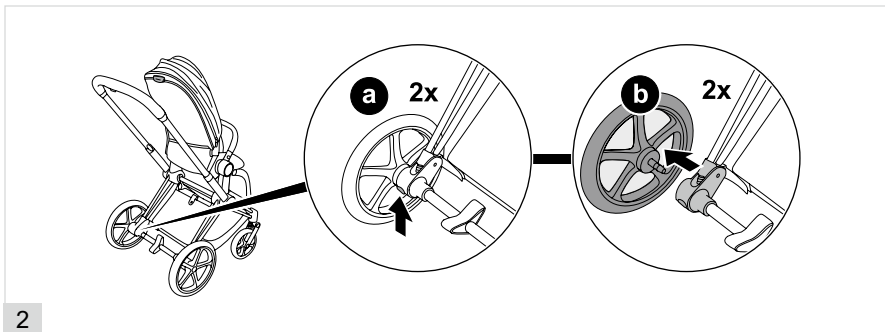
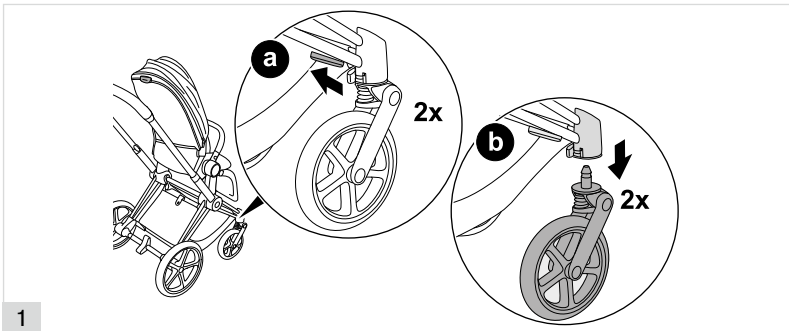

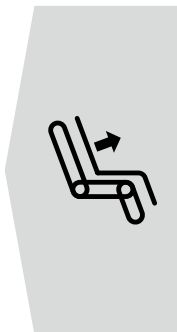
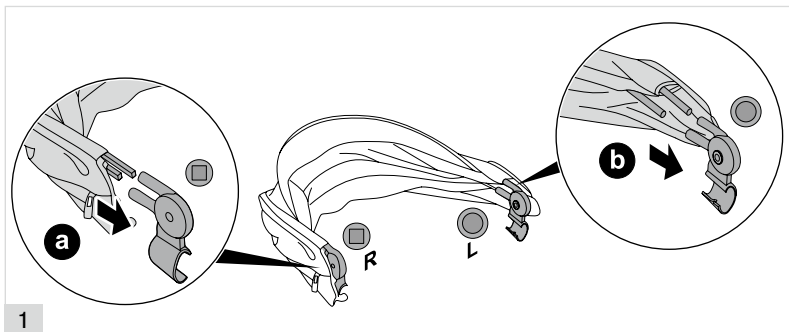

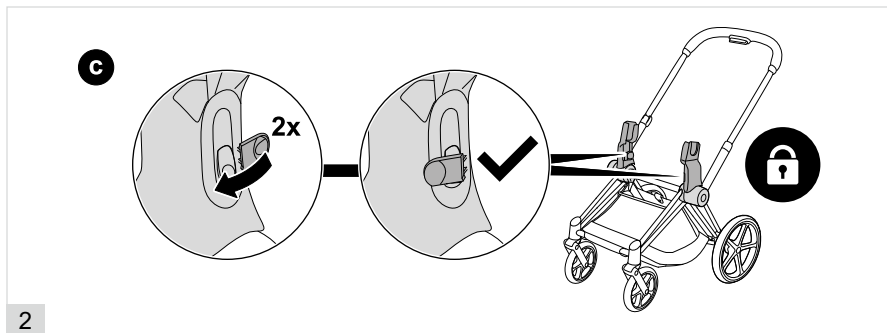
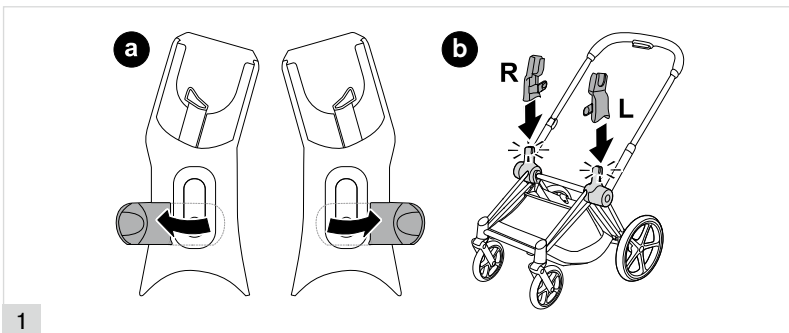

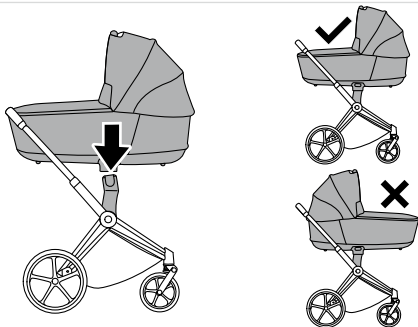

3

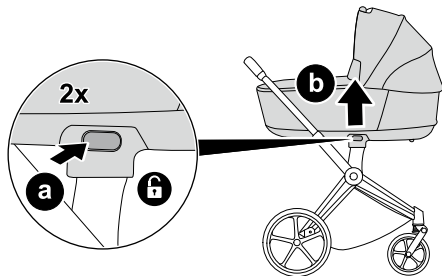

4

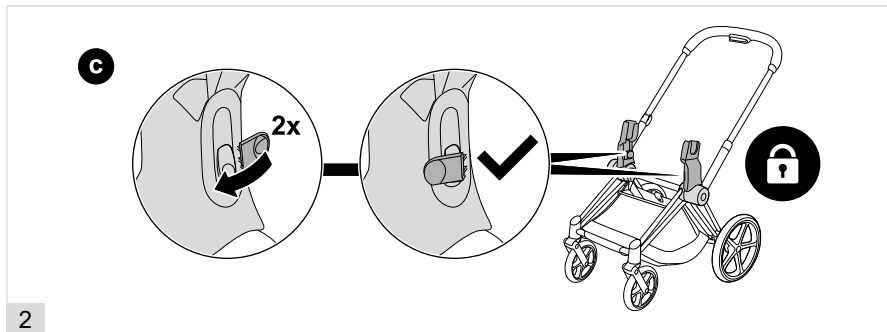
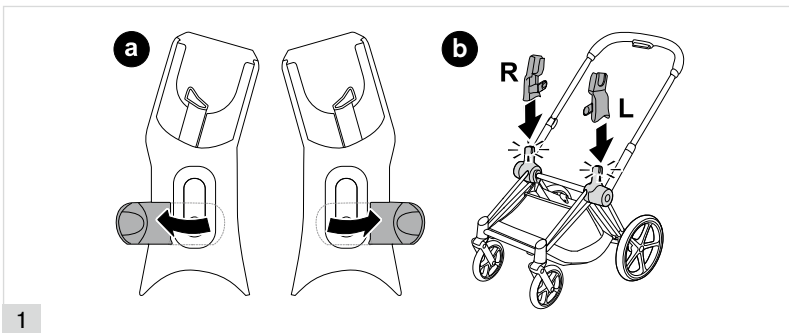

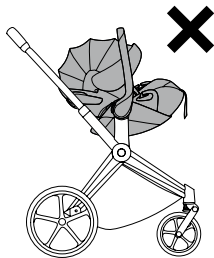
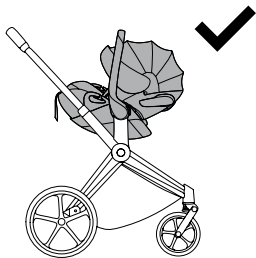
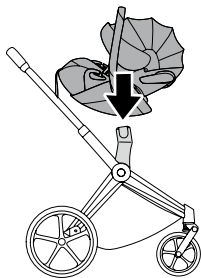

3

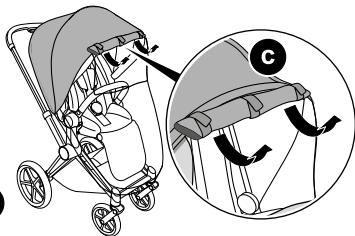
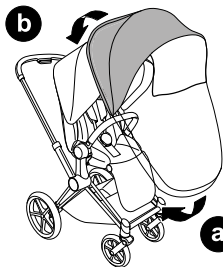

1





CYBEX GmbH

Riedingerstr. 18 | 95448 Bayreuth | Germany
+49 (0) 921-78 511-0 | info@cybex-online.com

www.cybex-online.com

